

TAVOLO - NEVADA - TABLE

NEVADA Paola Navone

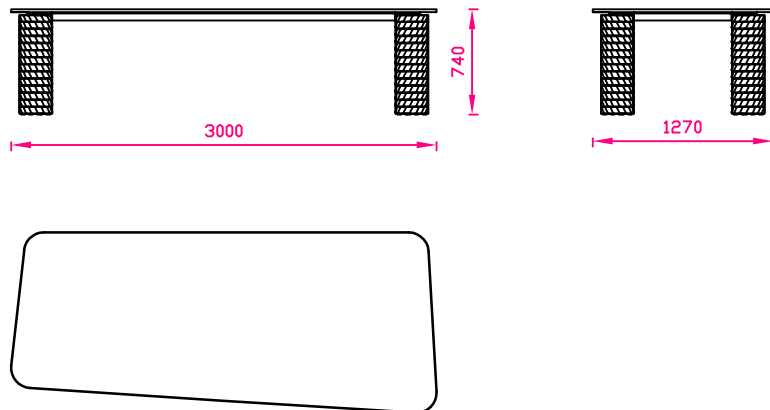

300 x 127 h 74
Tavola / Table



COMPONENTI

n° 01 - Top in marmo

n° 01 - Telaio in metallo

n° 04 - Gambe in metallo

n° 48 - Moduli Singoli di Terracotta

n° 04 - Moduli Doppi di Terracotta

n° 52 - Moduli Cilindrici di gomma

n° 16 - Viti 8 Ma x 20 mm con Testa Svasata

n° 08 - Viti 5 Ma x 25 mm con Testa Cilindrica

n° 04 - Viti 6 Ma x 15 mm con Testa Bombata + Rondella Vern. nera ϕ 25 mm

COMPONENTS

n° 01 - Marble Top

n° 01 - Metal Frame

n° 04 - Metal Legs

n° 48 - Backed clay Single Module

n° 04 - Backed clay Double Module

n° 52 - Cylindrical Foam Modules

n° 16 - Screws 8 Ma x 20 mm with flared head

n° 08 - Screws 5 Ma x 25 mm with cylindrical head

n° 04 - Screws 6 Ma x 15 mm with rounded head + Black Washer \varnothing 25 mm

1

Inserire la Gomma nei moduli in terracotta (Figura 1)
Insert the Foam in the Backed Clay Modules (Picture 1)

Decidere la Posizione del Tavolo.
Definire la posizione delle quattro gambe usando l'ingombro del telaio.
Telaio solo in Appoggio. (Figura 2)
Choose the right position of the Table.
Define the right position of the four legs using the metal frame
Metal Frame only layed (Picture 2)

Trovata la posizione delle gambe rimuovere il telaio in metallo
e calzare i moduli in terracotta su ogni gamba (Figura 3,4,5,6)
Found the right position of the legs, remove the metal Frame and
put the Backed Clay Module on each leg. (Picture 3,4,5,6)

Avvitare Il telaio alle gambe (Figura 7,8)
Screw the Metal Frame to the legs (Picture 7,8)

Fissare il top in marmo (Figura 8,9)
Fix the Marble Top (Picture 8,9)

Assemblaggio completato (Figura 10)
The assembly is completed (Picture 10)

Figura 1 - Picture 1

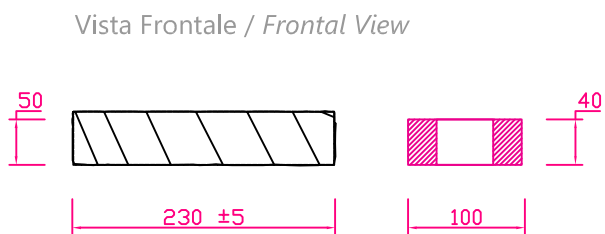

Pianta / Plan

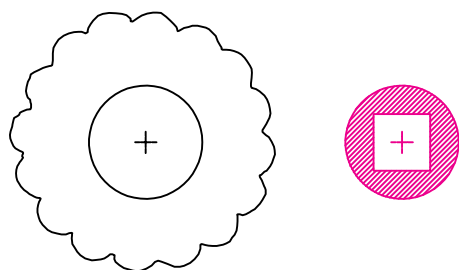

Gomma / Foam

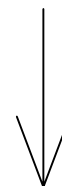

Modulo Terracotta
Backed clay Module

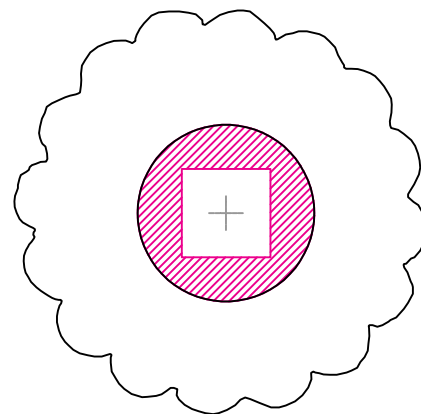

Modulo Completo
Complete Module

Figura 2 - Picture 2

Pianta / Plan

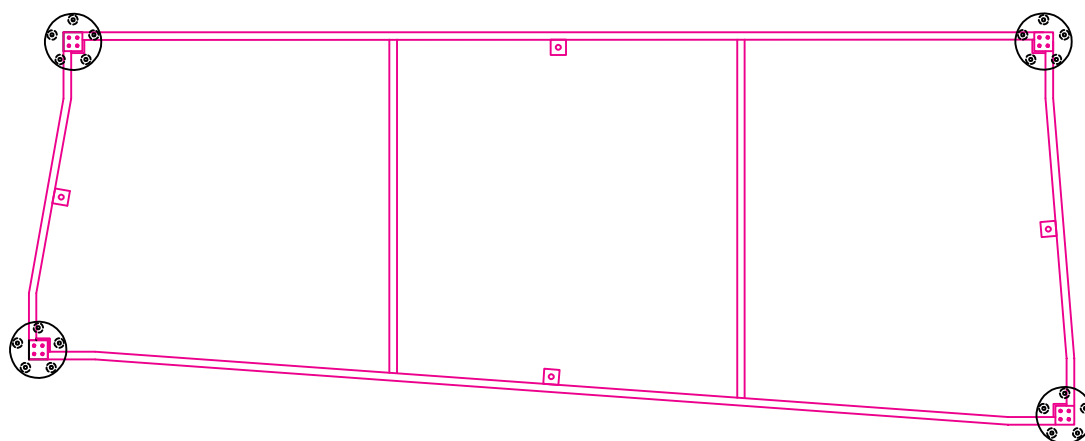

Vista Frontale / Frontal View



Figura 3 - *Picture 3*

Prospetto Frontale / *Frontal View*

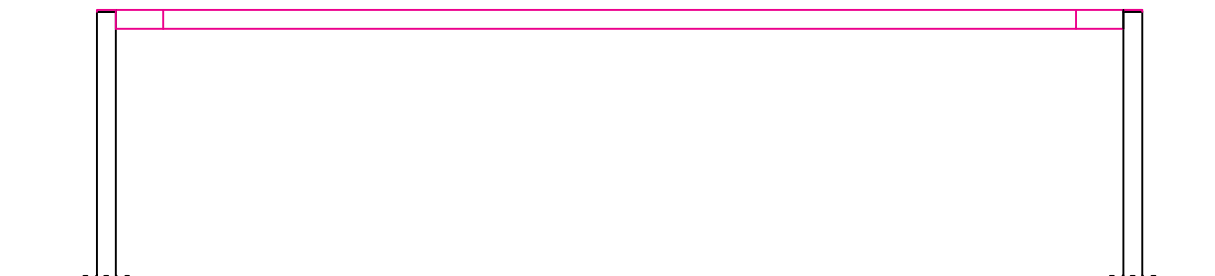

Figura 4 - Picture 4

Prospetto Frontale / Frontal View



Figura 5 - Picture 5

Prospetto Frontale / Frontal View

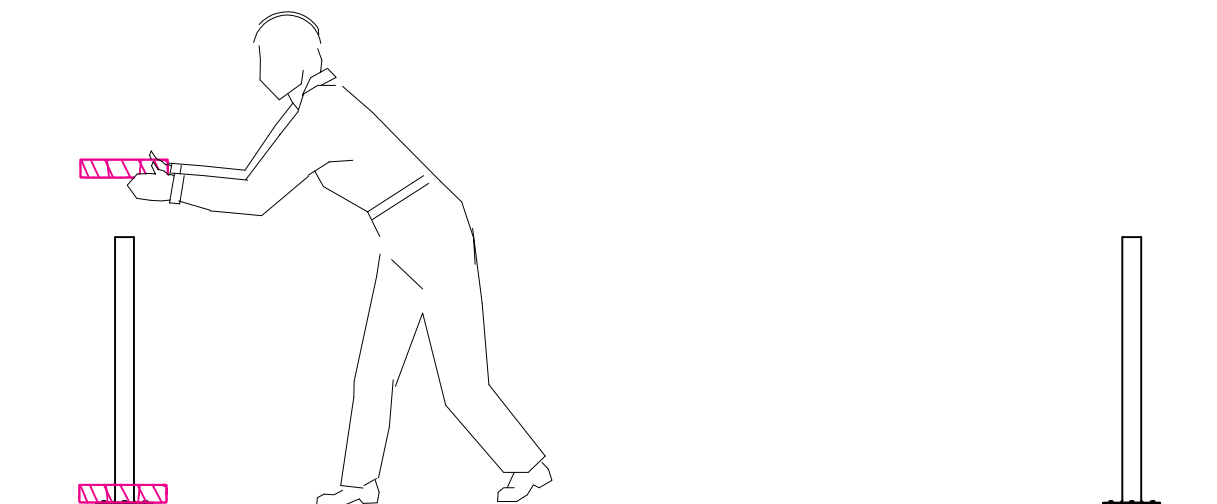
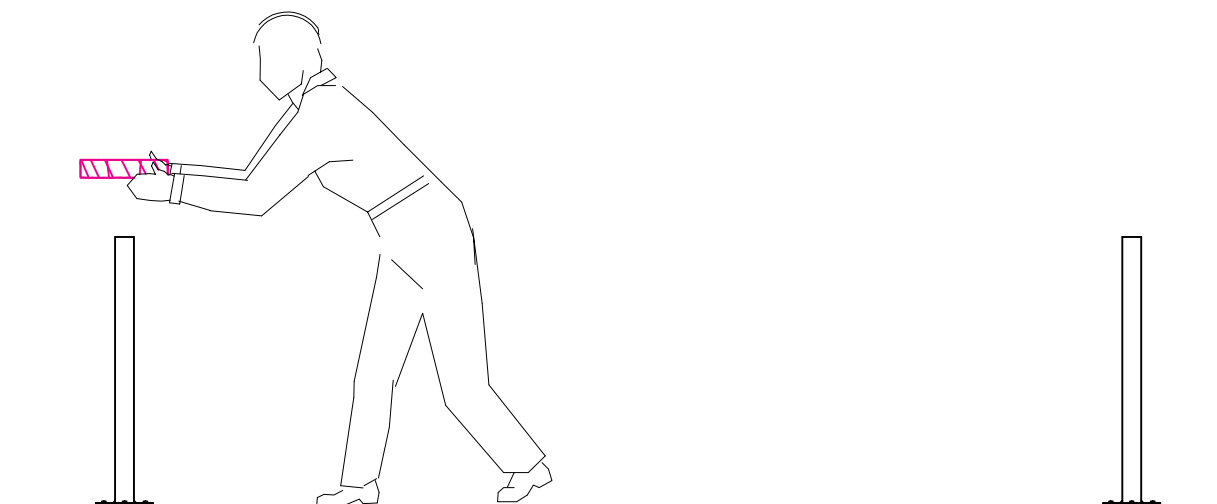

Figura 6 - Picture 6

Prospetto Frontale / Frontal View



n° 1 Modulo Doppio / Double Module

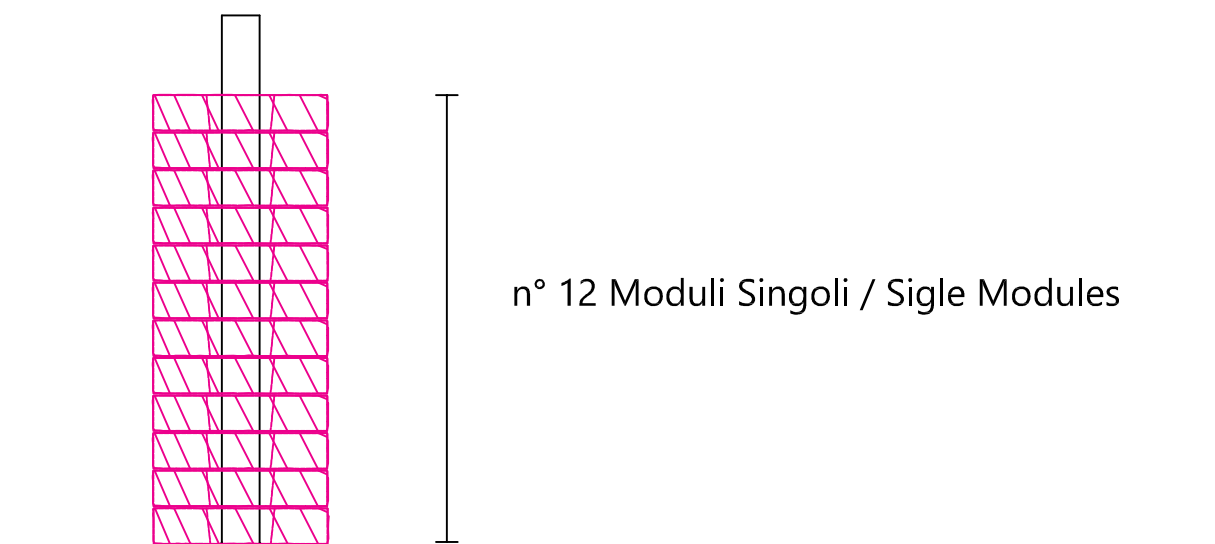

Figura 7 - Picture 7

Prospetto Frontale / Frontale View

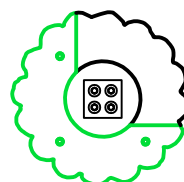
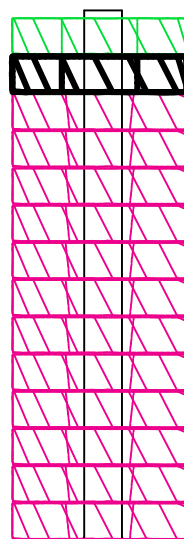
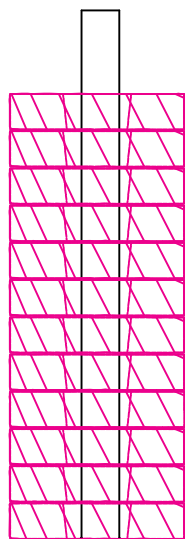
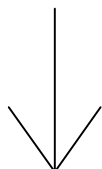

Figura 8 - Picture 8

Pianta / Plan

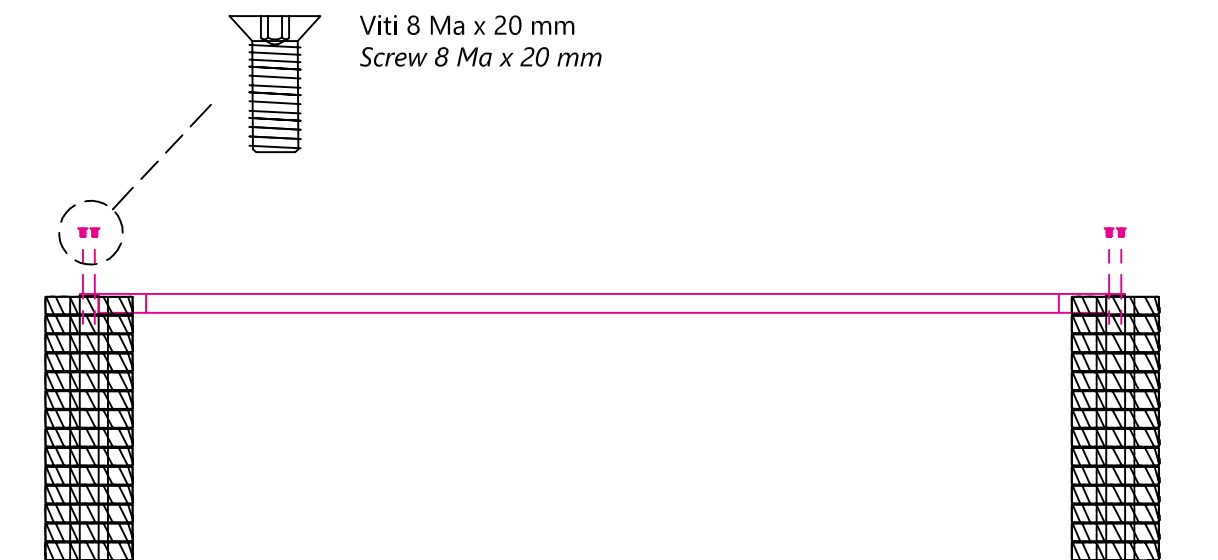
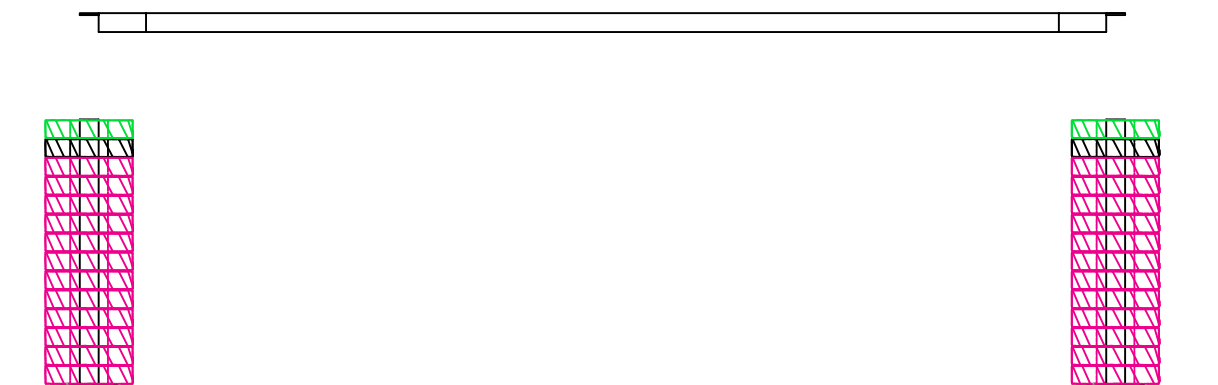
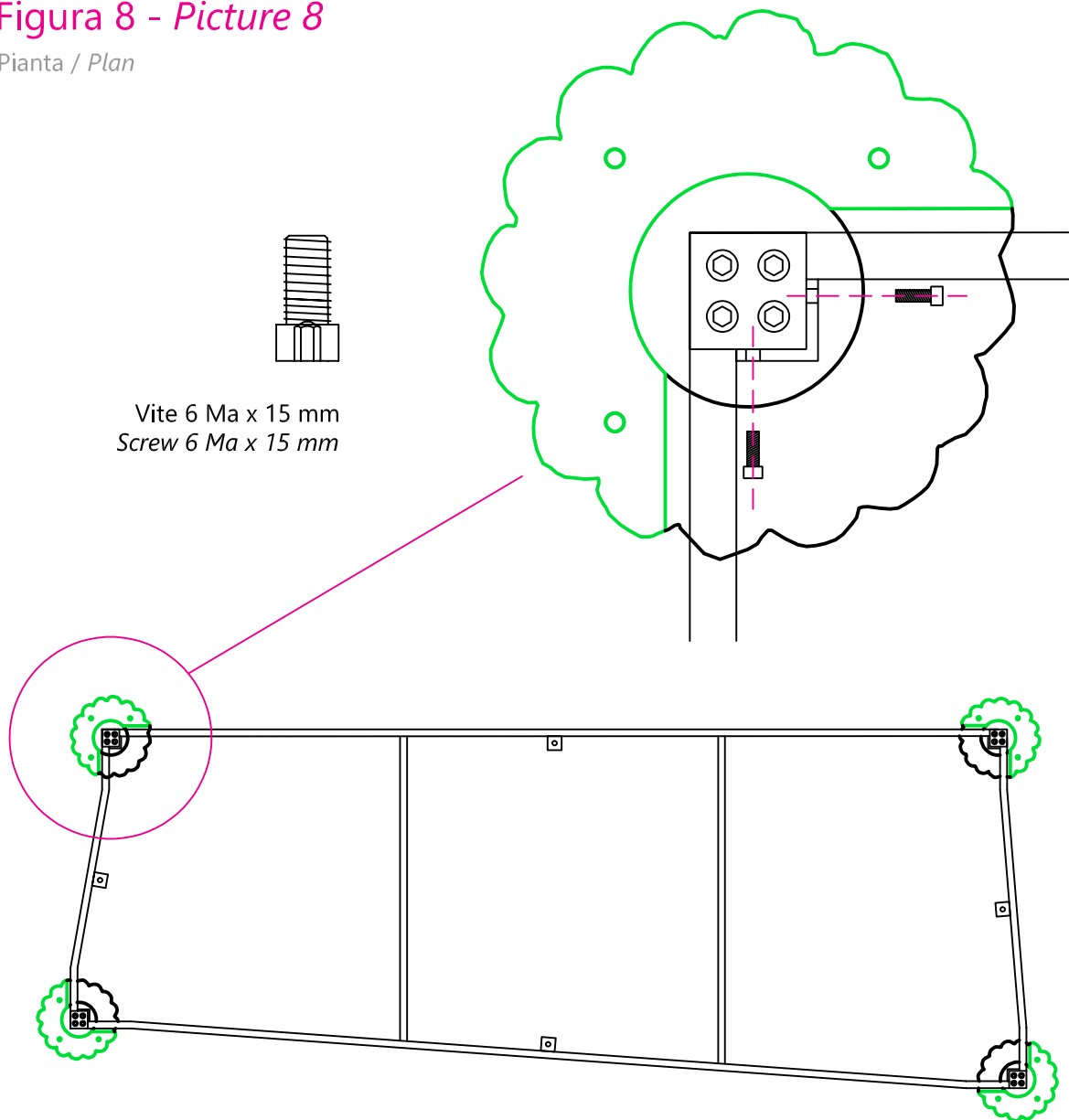

Prospetto Frontale / Frontal View

Top Marmo
Marble Top



Figura 9 - Picture 9

Prospetto Frontale e Pianta / Frontal View and Plan



Piastrine per il fissaggio del Top Marmo
Metal Plate to fix the Marble Top

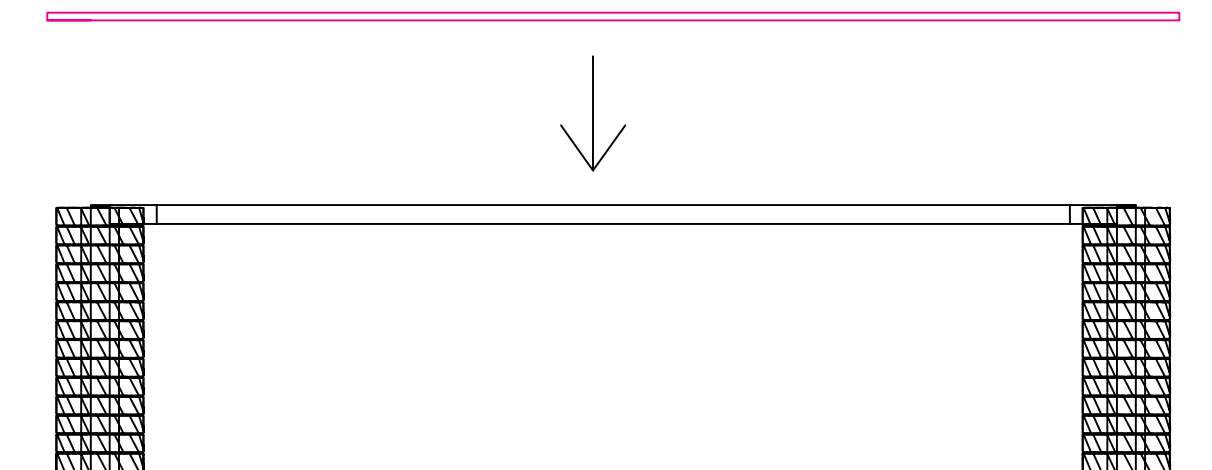
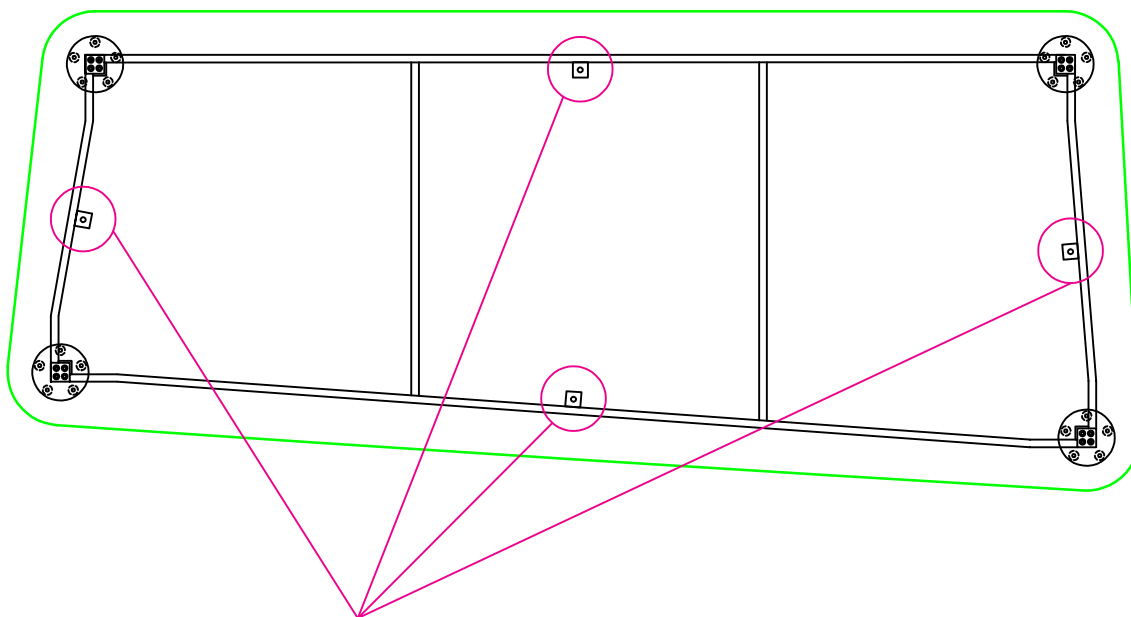
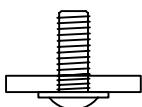
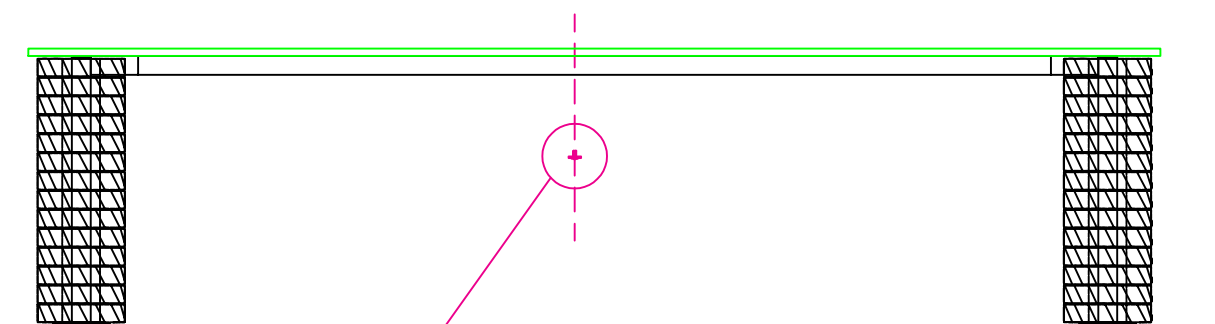

Vite 6 Ma x 15 mm
Screw 6 Ma x 15 mm

Figura 10 - Picture 10

Prospetto Frontale / Frontal View

