

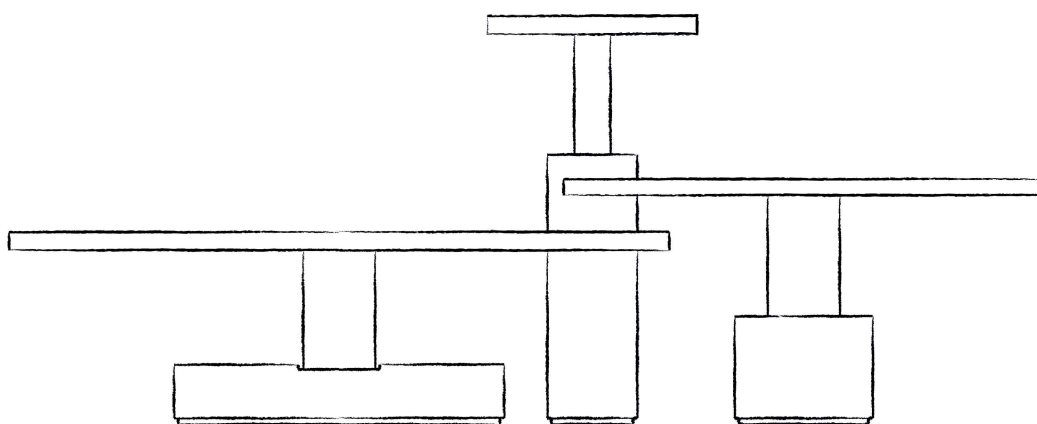

MADE IN ITALY



TAVOLINO - PILAR - SMALL TABLE

PILAR Baxter



ø35 h 70
Small table

$\frac{70\text{cm}}{27\frac{1}{4}}"$

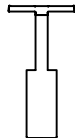

$\frac{35\text{cm}}{13\frac{3}{4}}"$



$\frac{35\text{cm}}{13\frac{3}{4}}"$

$\frac{35\text{cm}}{13\frac{3}{4}}"$

ø50 h 50
Small table

$\frac{50\text{cm}}{19\frac{1}{2}}"$

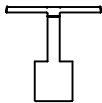

$\frac{50\text{cm}}{19\frac{1}{2}}"$

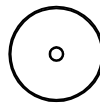

$\frac{50\text{cm}}{19\frac{1}{2}}"$

$\frac{50\text{cm}}{19\frac{1}{2}}"$

ø80 h 41
Small table

$\frac{41\text{cm}}{16}"$

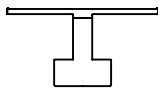

$\frac{80\text{cm}}{31\frac{1}{4}}"$

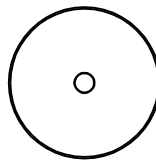

$\frac{80\text{cm}}{31\frac{1}{4}}"$

$\frac{80\text{cm}}{31\frac{1}{4}}"$

∅80 h 65
Small table

$\frac{65\text{cm}}{25\frac{1}{4}"}$

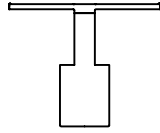

$\frac{80\text{cm}}{31\frac{1}{4}"}$

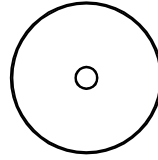

$\frac{80\text{cm}}{31\frac{1}{4}"}$

$\frac{80\text{cm}}{31\frac{1}{4}"}$

∅110 h 32
Small table

$\frac{32\text{cm}}{12\frac{1}{2}"}$

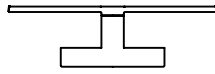

$\frac{110\text{cm}}{43}"$

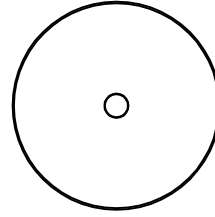

$\frac{110\text{cm}}{43}"$

$\frac{110\text{cm}}{43}"$

∅110 h 65

Small table

$\frac{65\text{cm}}{25\frac{1}{4}"}$

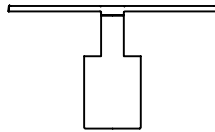

$\frac{110\text{cm}}{43}"$

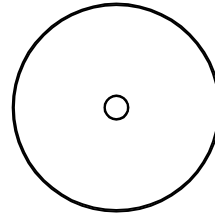

$\frac{110\text{cm}}{43}"$

$\frac{110\text{cm}}{43}"$

COMPONENTI | COMPONENTS

Ø35 h 70 Già montato
Small table *Already assembled*

Ø50 h 50 Già montato
Small table *Already assembled*

Ø80 h 41 n°01 Top in cemento Ø80 h5cm - Ø31 $\frac{1}{4}$ " h 2"
Small table n°01 Concrete top Ø80 h5cm - Ø31 $\frac{1}{4}$ " h 2"
n°01 Gamba in cemento
n°01 Concrete leg

Ø80 h 65 n°01 Top in cemento Ø80 h5cm - Ø31 $\frac{1}{4}$ " h 2"
Small table n°01 Concrete top Ø80 h5cm - Ø31 $\frac{1}{4}$ " h 2"
n°01 Gamba in cemento
n°01 Concrete leg

Ø110 h 32 n°01 Top in cemento Ø110 h5cm - Ø43" h 2"
Small table n°01 Concrete top Ø110 h5cm - Ø43" h 2"
n°01 Gamba in cemento
n°01 Concrete leg

Ø110 h 65 n°01 Top in cemento Ø110 h5cm - Ø43" h 2"
Small table n°01 Concrete top Ø110 h5cm - Ø43" h 2"
n°01 Gamba in cemento
n°01 Concrete leg

1

Estrarre i moduli dalle casse.

Remove the concrete top and leg from the wood box.

Avvitare il top alla base. (Figura 1 - Fase 1)

Tighten the concrete top to the leg.(Picture 1 - Step 1)

Montaggio Completato. (Figura 2 - Fase 2)

Assembly completed. (Picture 2 - Step 2)

Figura 1 - Picture 1

Fase 1 - Step 1

Vista assonometrica / *Isometric view*



Figura 2 - Picture 2

Fase 2 - Step 2

Vista frontale / Front view

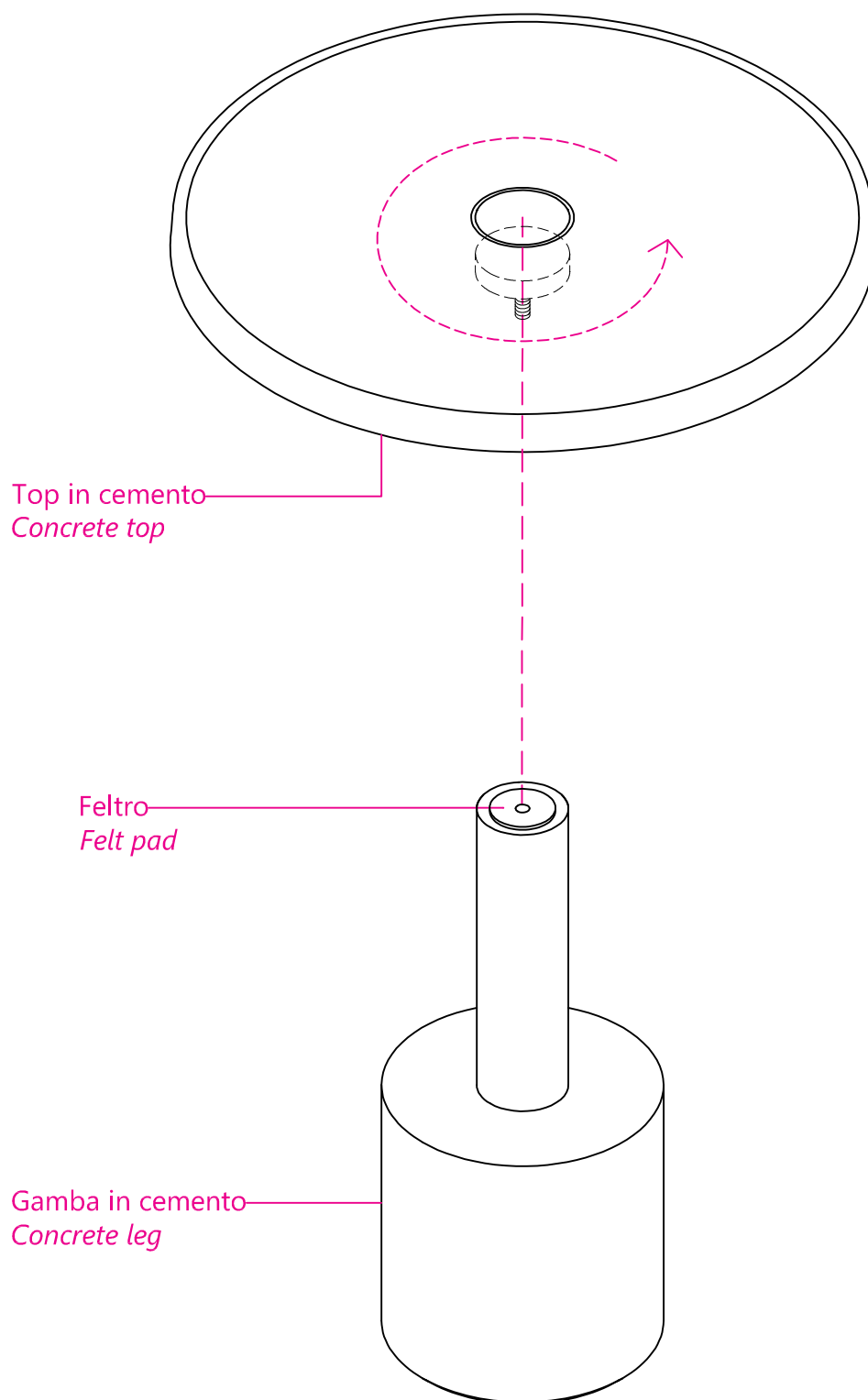