

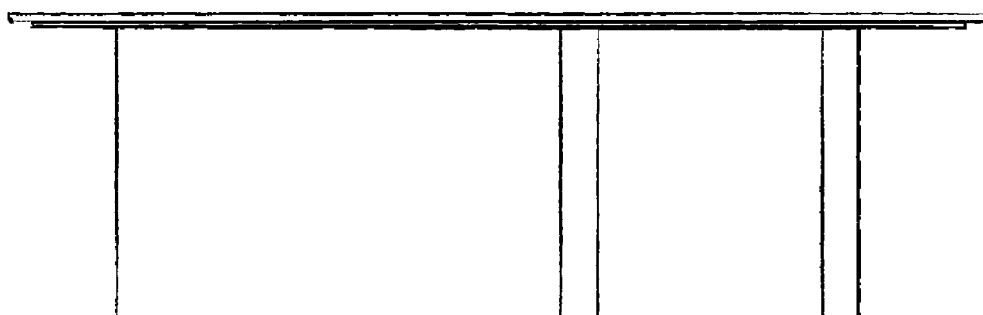

---

MADE IN ITALY



TAVOLO - RONCHAMP - TABLE

# RONCHAMP Baxter



240 x 130 h 74  
Tavolo / Table

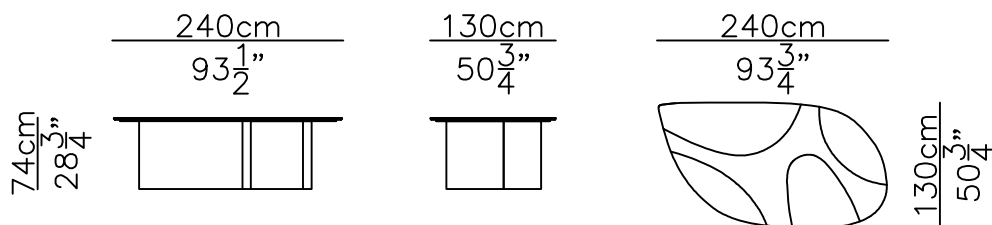

280 x 150 h 74  
Tavolo / Table

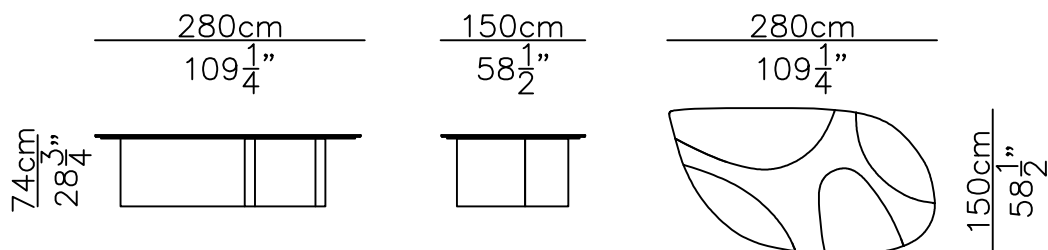

240 x 130 h 74  
Tavolo / Table

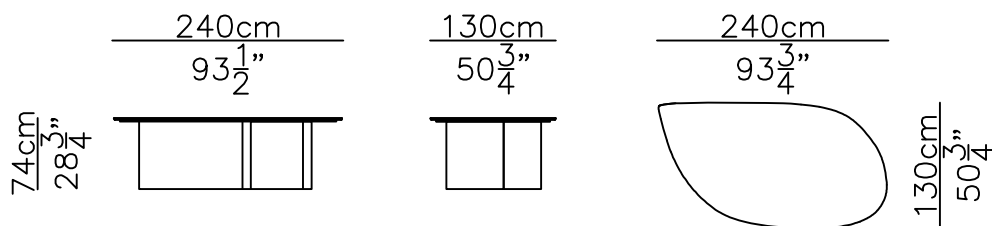

280 x 150 h 74  
Tavolo / Table

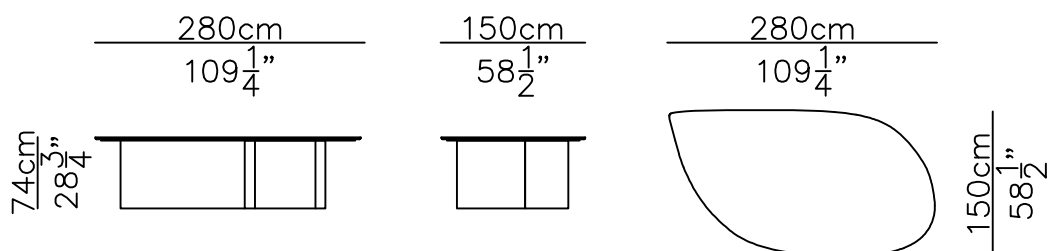

# COMPONENTI

n° 01 - Top in marmo

n° 02 - Gambe in polimex

n° 01 - Piano in alluminio sp. 4mm ( $\frac{1}{6}$ " )

n° 06 - Vite M6x30 mm nera testa svasata

n° 05 - Vite M6x10 mm testa bombata flangiata nichelata

# COMPONENTS

n° 01 - Marble top

n° 02 - Table leg in polimex

n° 01 - Aluminium sheet 4mm ( $\frac{1}{6}$ " ) thick

n° 06 - Black M6x30 mm flared head screw

n° 05 - Nickel M6x10 mm flange head screw

# 1

Smontare il piano in alluminio dal top in marmo svitando le viti a testa bombata flangiata. (Figura 1 - Fase 1 )

*Remove the aluminium sheet from the marble top by unscrewing the flange head screws. ( Picture 1 - Step 1 )*

Togliere la pellicola protettiva dal piano in alluminio. Avvitare dall'alto la lamiera in alluminio alle due gambe con n° 3 viti a testa svasata ciascuna.

( Figura 2,3 - Fase 2 )

*Remove the protective film from the aluminium sheet. Screw from above the aluminium sheet to the legs by n°3 flared head screw each.*

( Picture 2,3 - Step 2 )

Regolare i piedini sotto ogni gamba in modo che il tavolo sia stabile

( Figura 4 - Fase 3 )

*Adjust the feet under each leg so that the table can be stable.*

( Picture 4 - Step 3 )

Posizionare la base del tavolo nella sua corretta posizione. Appoggiare il top in marmo sulla lamiera, allineando lo spigolo delle lamiere in metallo. Avvitare la vite in corrispondenza dello spigolo della lamiera.

( Figura 5 - Fase 4 )

*Locate the table legs in the right position. Put the marble top on the aluminium sheet. At first align the sharp edge of the metal sheets. Screw the first nichel flat head screw in order to fix the table top to its base. ( Picture 5 - Step 4 )*

Ruotare il top in modo da allineare i fori mancanti. Avvitare le viti a testa piatta nichelata rimanenti da sotto.

(Figura 6,7 - Fase 5 )

*Rotate the marble top in order to align all the holes.*

*Fasten all the remaining nichel flat head screws from below.*

(Picture 6,7 - Step 5 )

Montaggio Completato. ( Figura 7 - Fase 6 )

*Assembly completed. ( Picture 7 - Step 6 )*

# Figura 1 - Picture 1

## Fase 1 - Step 1

Pianta / Top view

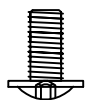
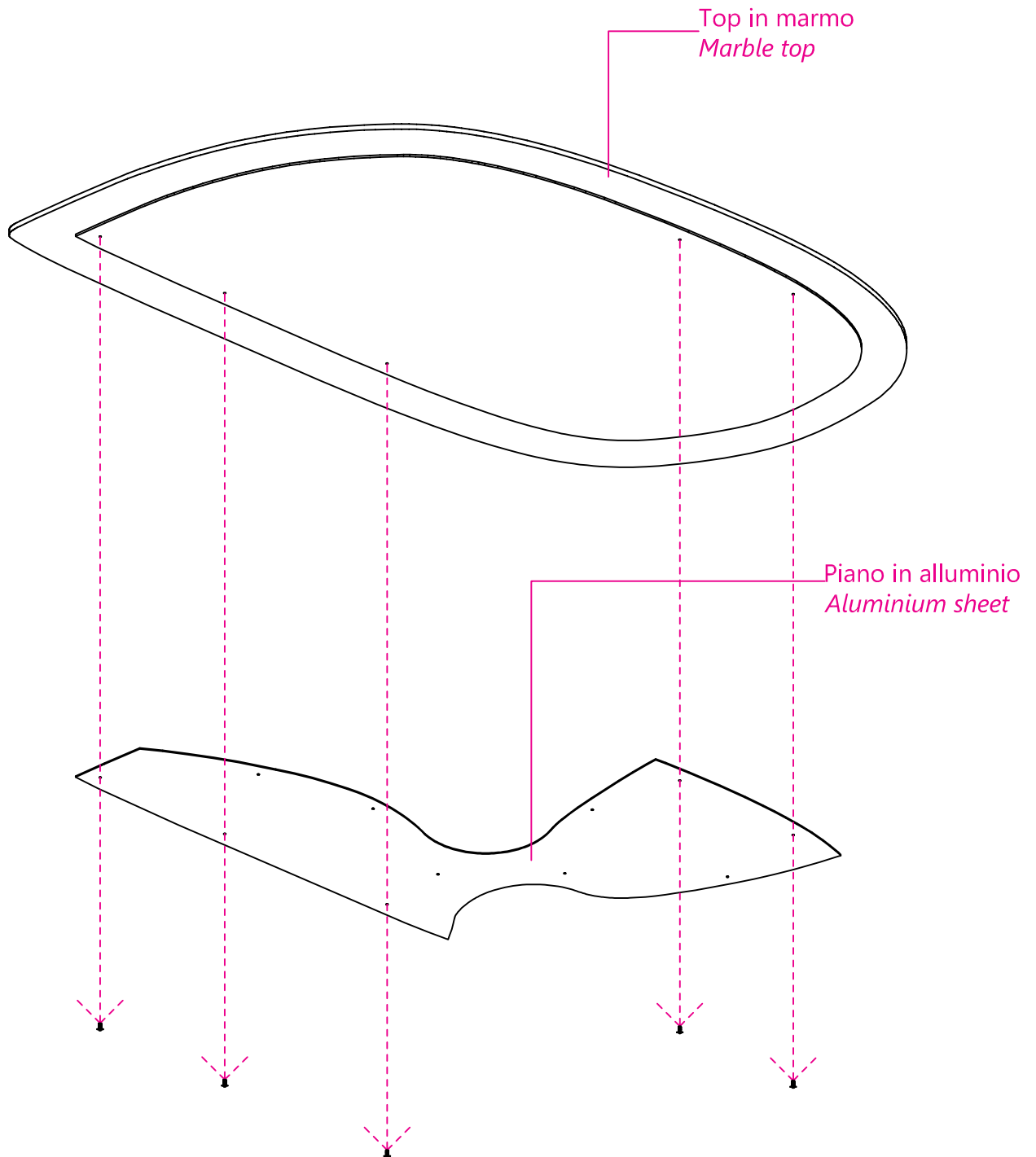

Vite a testa piatta M6x10 mm nichelata  
*Nickel screw with Flange head M6x10 mm*

## Figura 2 - Picture 2

### Fase 2 - Step 2

Pianta / Top view

Togliere la pellicola protettiva dal piano in alluminio prima di fissarlo alle gambe del tavolo.  
*Remove the protective film from the aluminium sheet before fastening it to the table legs.*

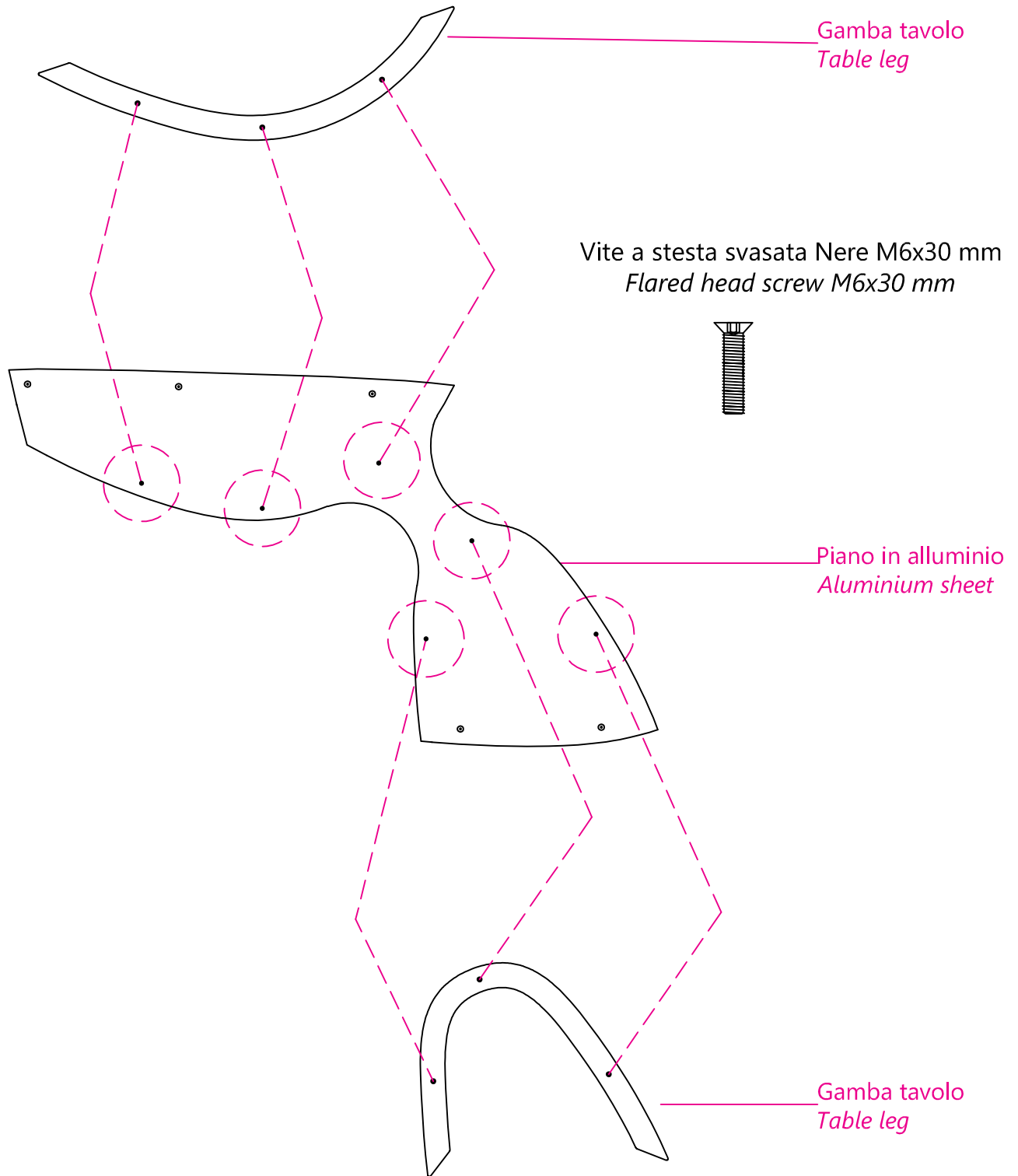

# Figura 3 - Picture 3

## Fase 2 - Step 2

Prospetto Laterale / *Lateral View*

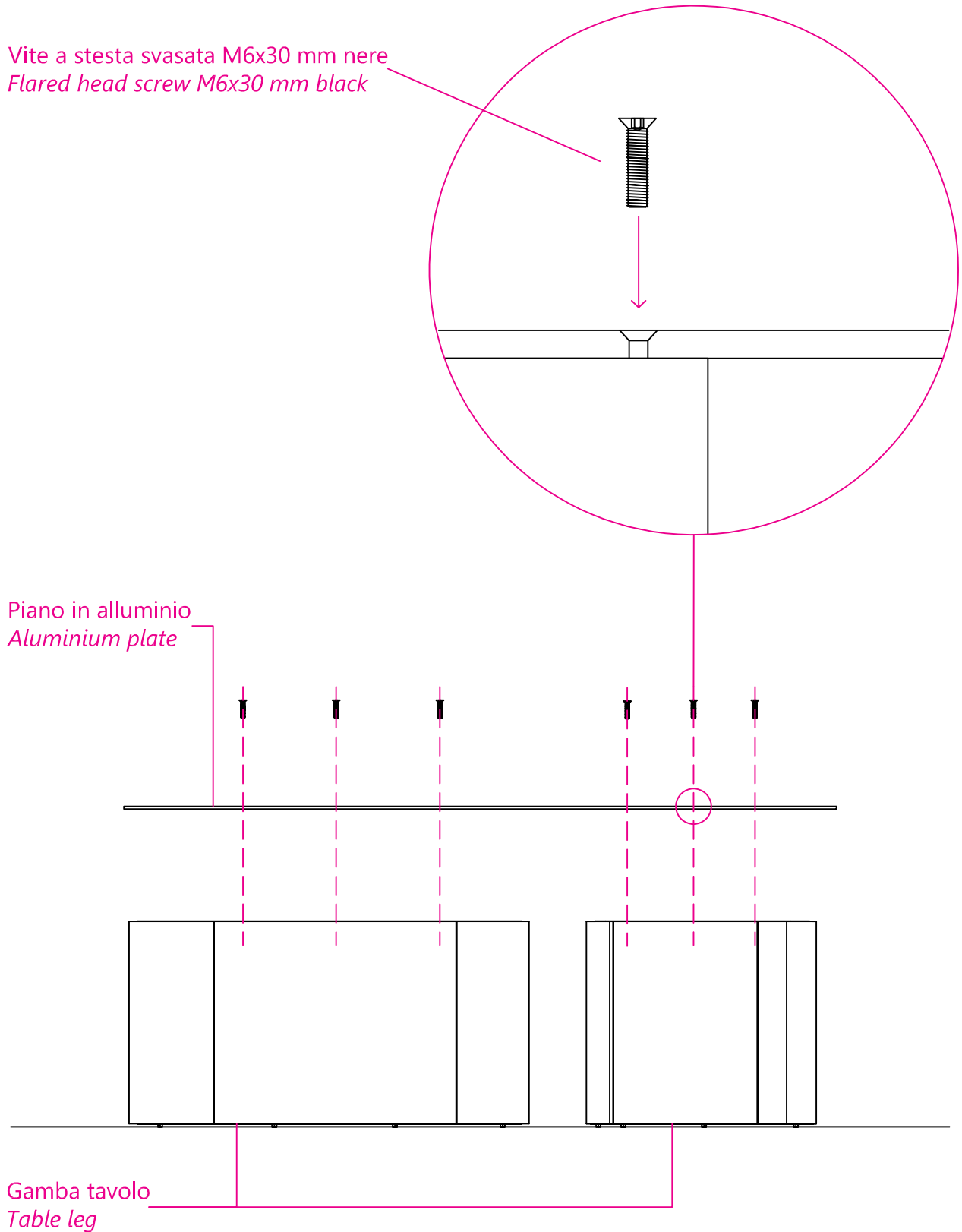

## Figura 4 - Picture 4

### Fase 3 - Step 3

Prospetto Laterale / Lateral view

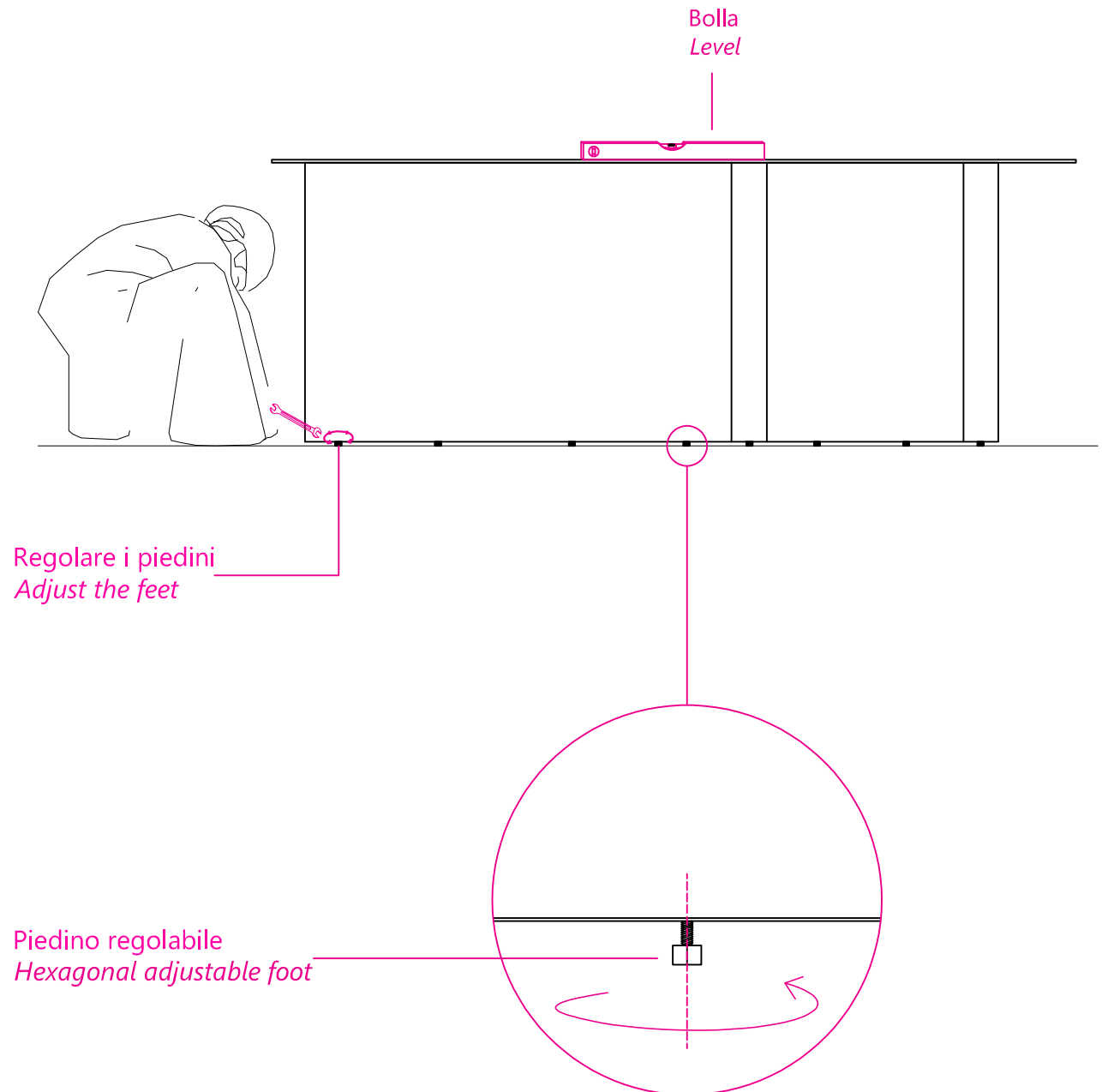



## Figura 5 - Picture 5

### Fase 4 - Step 4

Prospetto Laterale / Lateral view

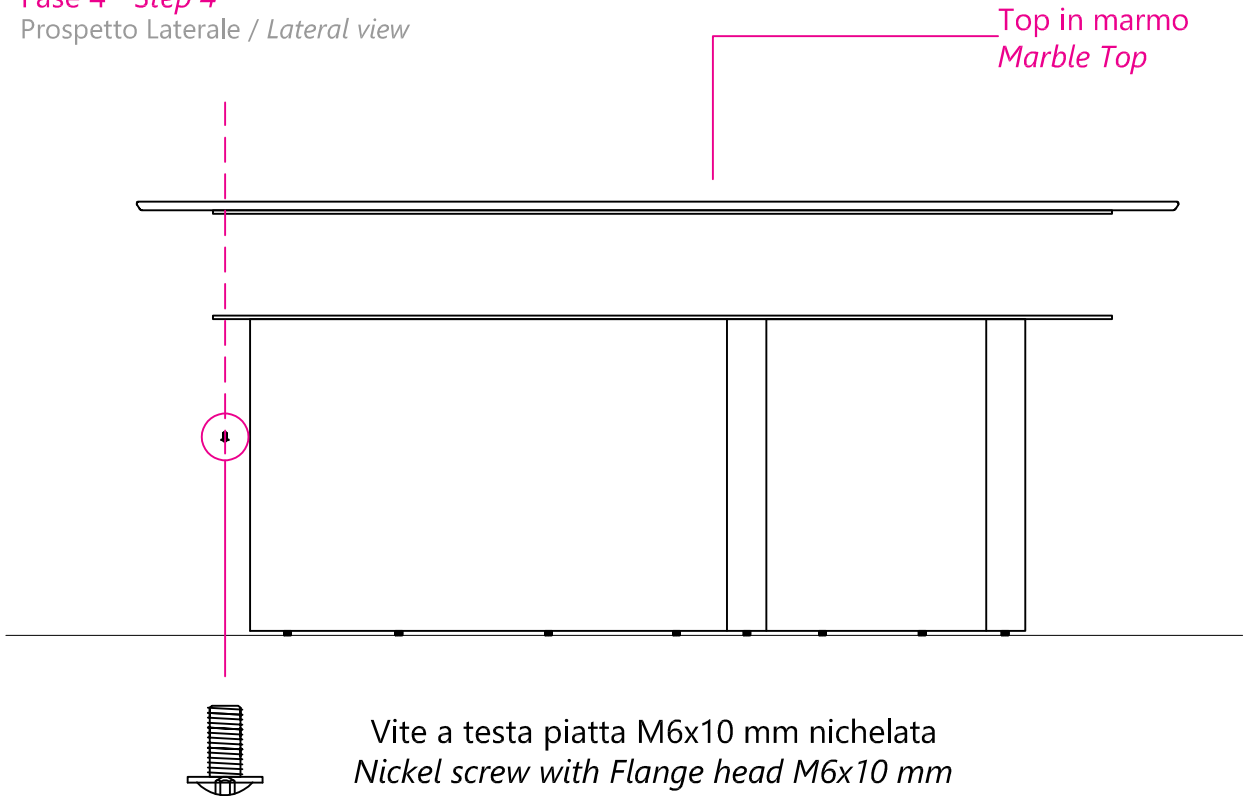

Pianta / Top view

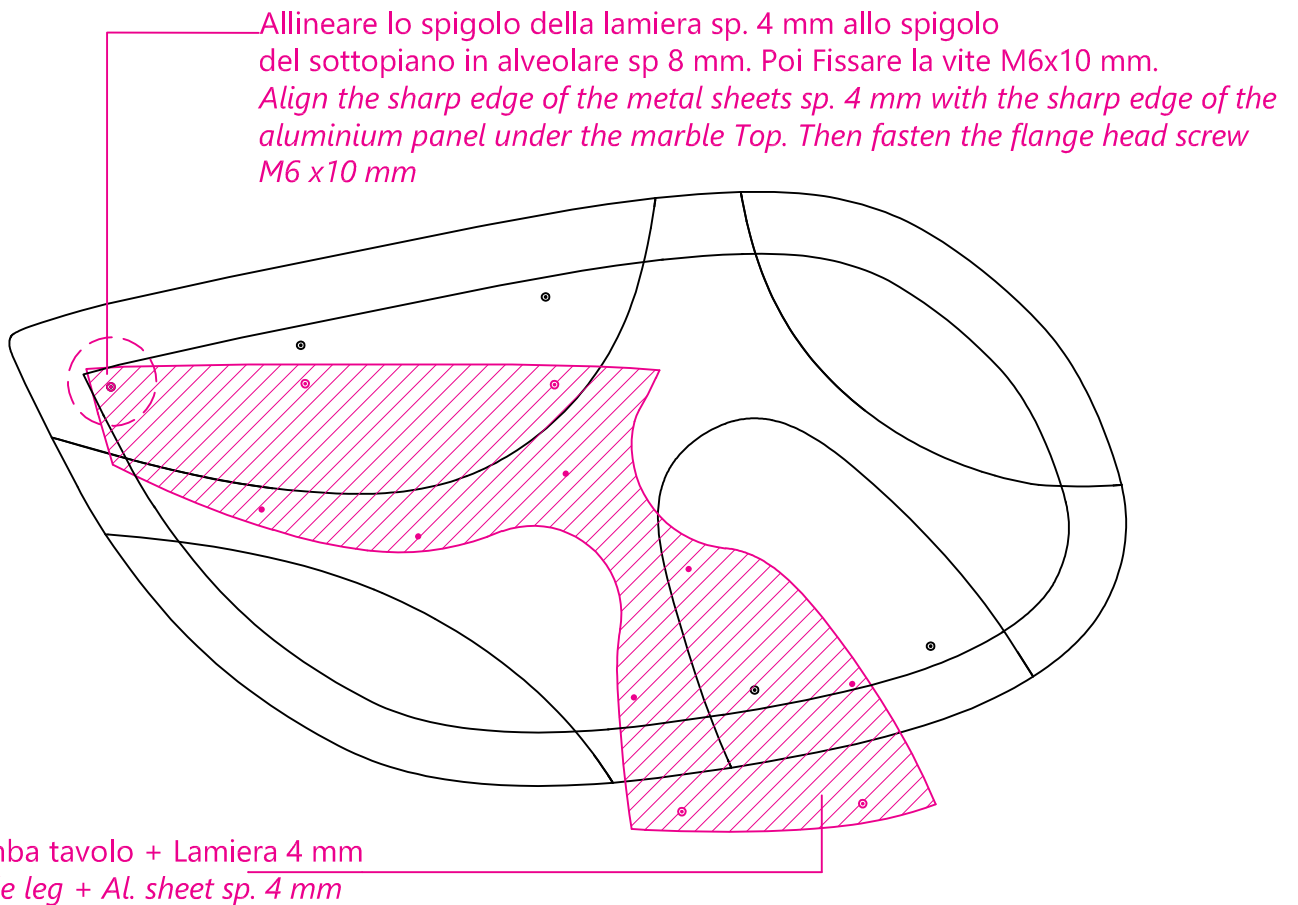

## Figura 6 - Picture 6

Fase 5 - Step 5  
Pianta / Top view

Ruotare il piano per trovare facilmente i restanti fori  
per il fissaggio del top  
*Rotate the Top to find easily the rest of the holes  
for fixing it*

PERNO ROTAZIONE  
ROTATION PIN

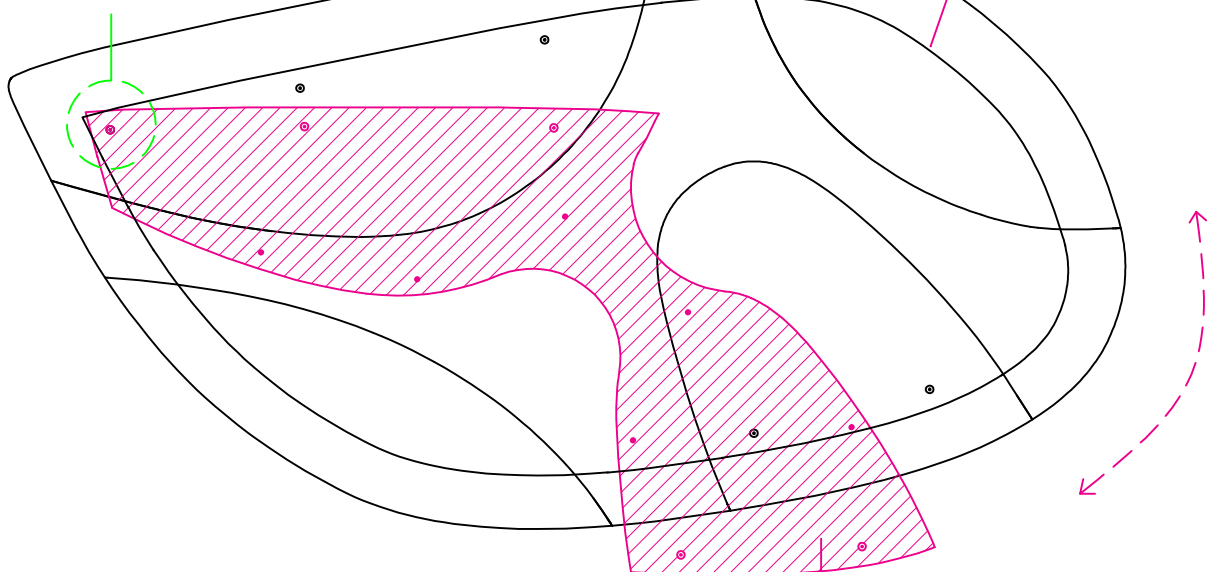

Gamba tavolo + Lamiera 4 mm  
Table leg + Al. sheet sp. 4 mm

Pianta / Top view

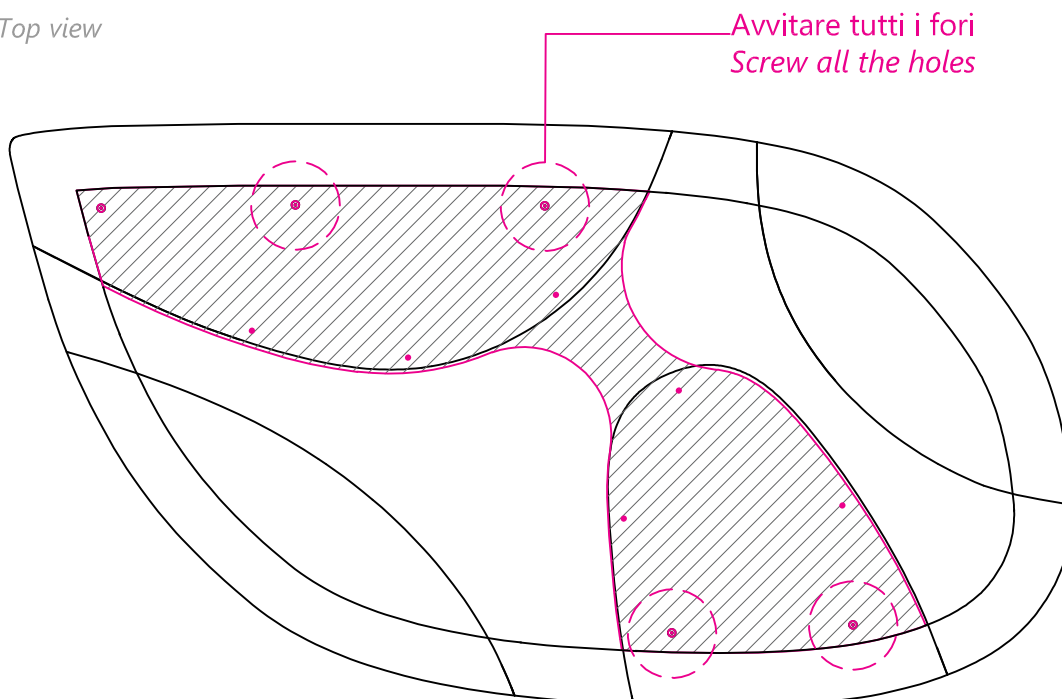

## Figura 7 - Picture 7

### Fase 6 - Step 6

Prospetto Laterale / Lateral view

Vite a testa piatta M6x10 mm nichelata  
Nickel screw with Flange head M6x10 mm

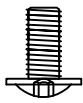
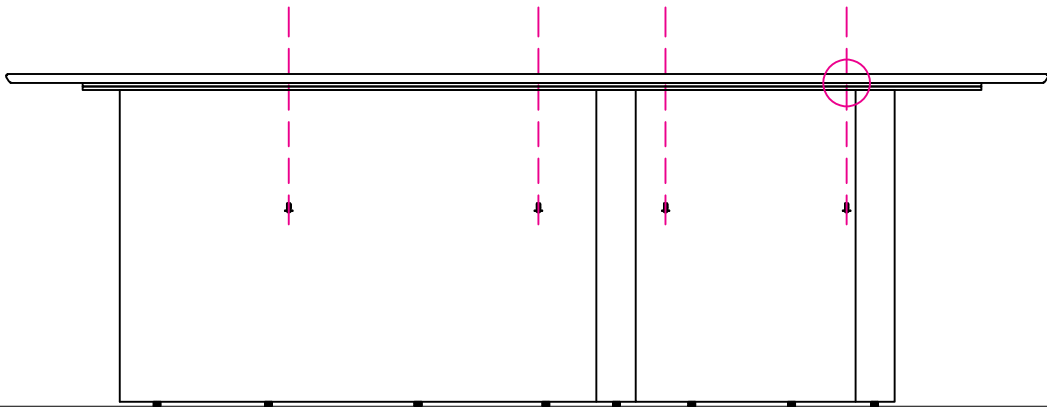
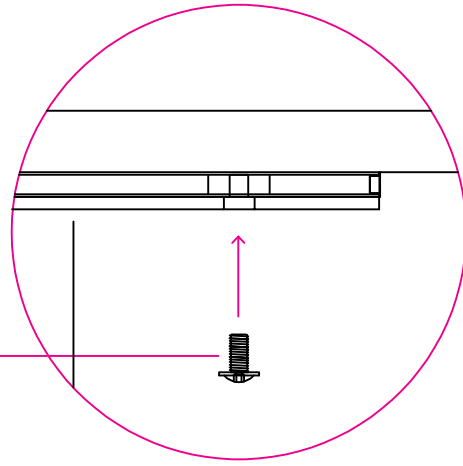

Vite a testa piatta M6x10 mm nichelata  
Nickel screw with Flange head M6x10 mm

Prospetto Laterale / Lateral view

